

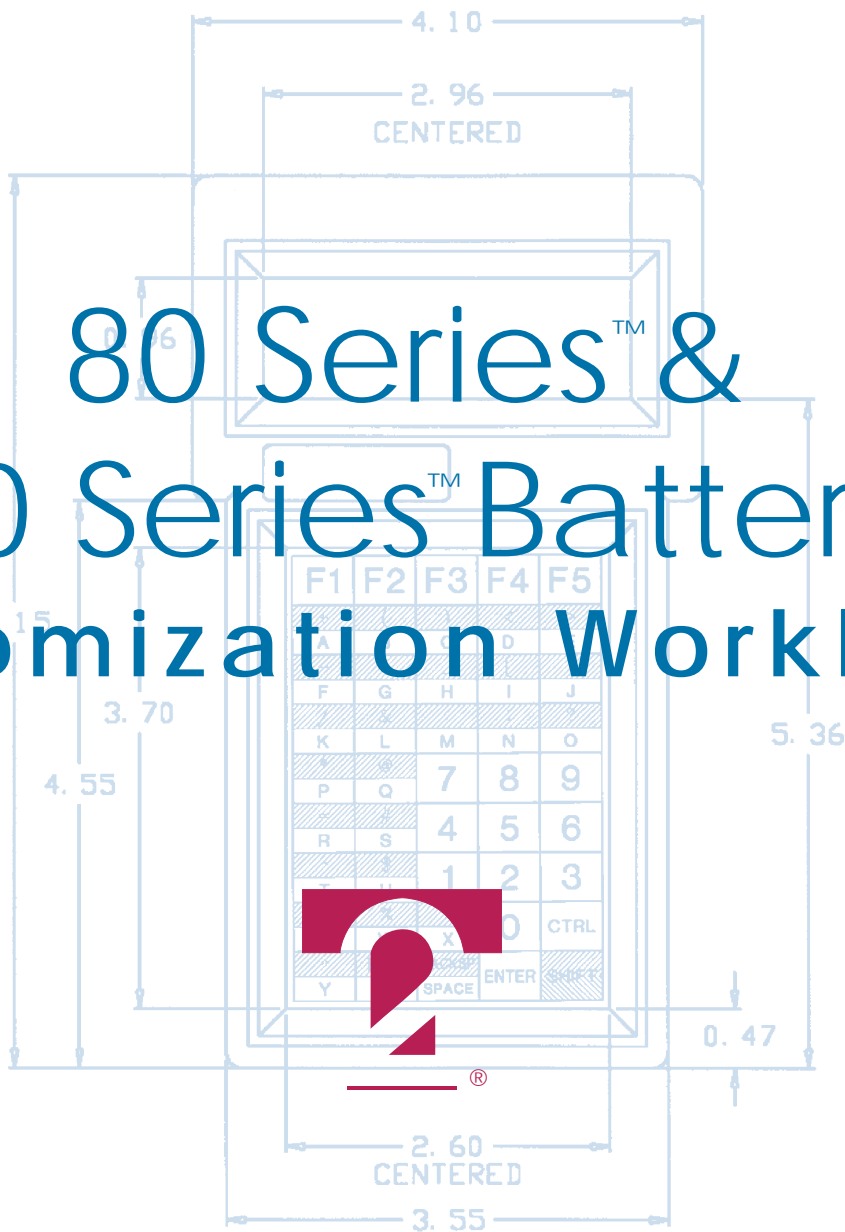

# 80 Series™ & 80 Series™ Battery Customization Workbook

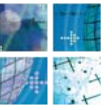



Thank you for downloading the customization booklet for the 80 Series™. Our objective is to supply you with the highest quality hand held computer products available—with all the custom features required for your unique application.

This workbook provides easy-to-use templates to customize the 80 Series for your application. To get started, just fill in your name and contact information and let the customization begin! If you have questions, just give us a call at 215.441.5305 and ask for Customer Service. No question is too simple when it comes to creating your masterpiece.

If you will not be providing camera-ready artwork, please sketch in the desired graphics and return the appropriate sheets indicating the particular items to be customized. Two Technologies uses the Pantone Matching System® Colors (uncoated colors only) to match all colors. Pantone® color guides are available at virtually any art supply store, or our customer service team can help you in selecting colors that best match your product or corporate colors.

The following features are customizable on the 80 Series:

- Case Color
- Keypad
- Logo tag
- Serial Tag
- Display
- Cable
- Custom defaults
- Custom key outputs
- Custom firmware
- Backlit or Phosphorescent keypad
- LEDs

We look forward to the opportunity to work with you on this project. Rest assured, we will provide you with a hand held computer you are proud to put your name on.

---

**Name:**

**Title:**

**Company:**

**Telephone Number:**

**E-Mail Address:**

# Case Dimensions

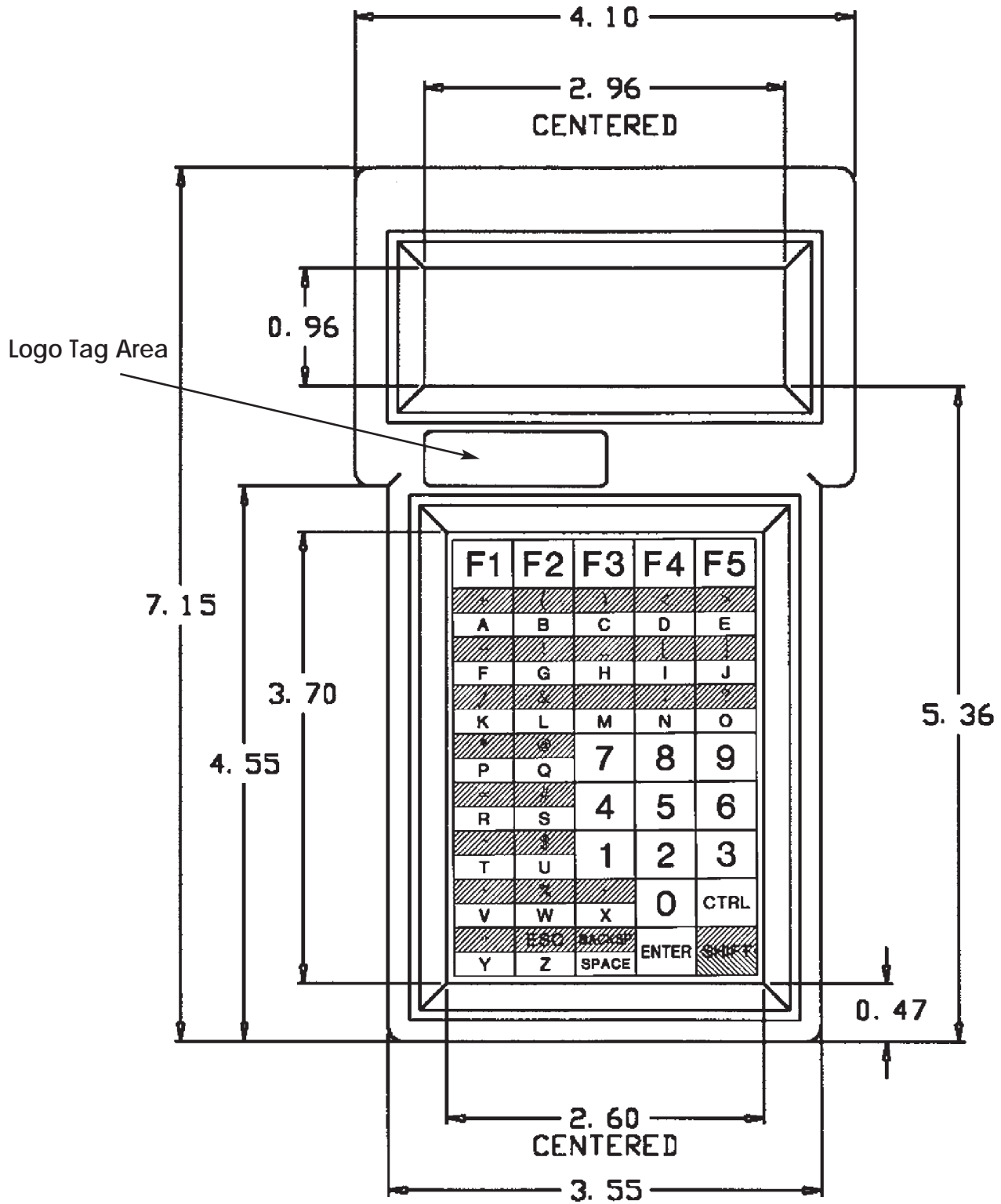
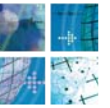

# Case Dimensions (with LED Logo Tag and E-Stop)

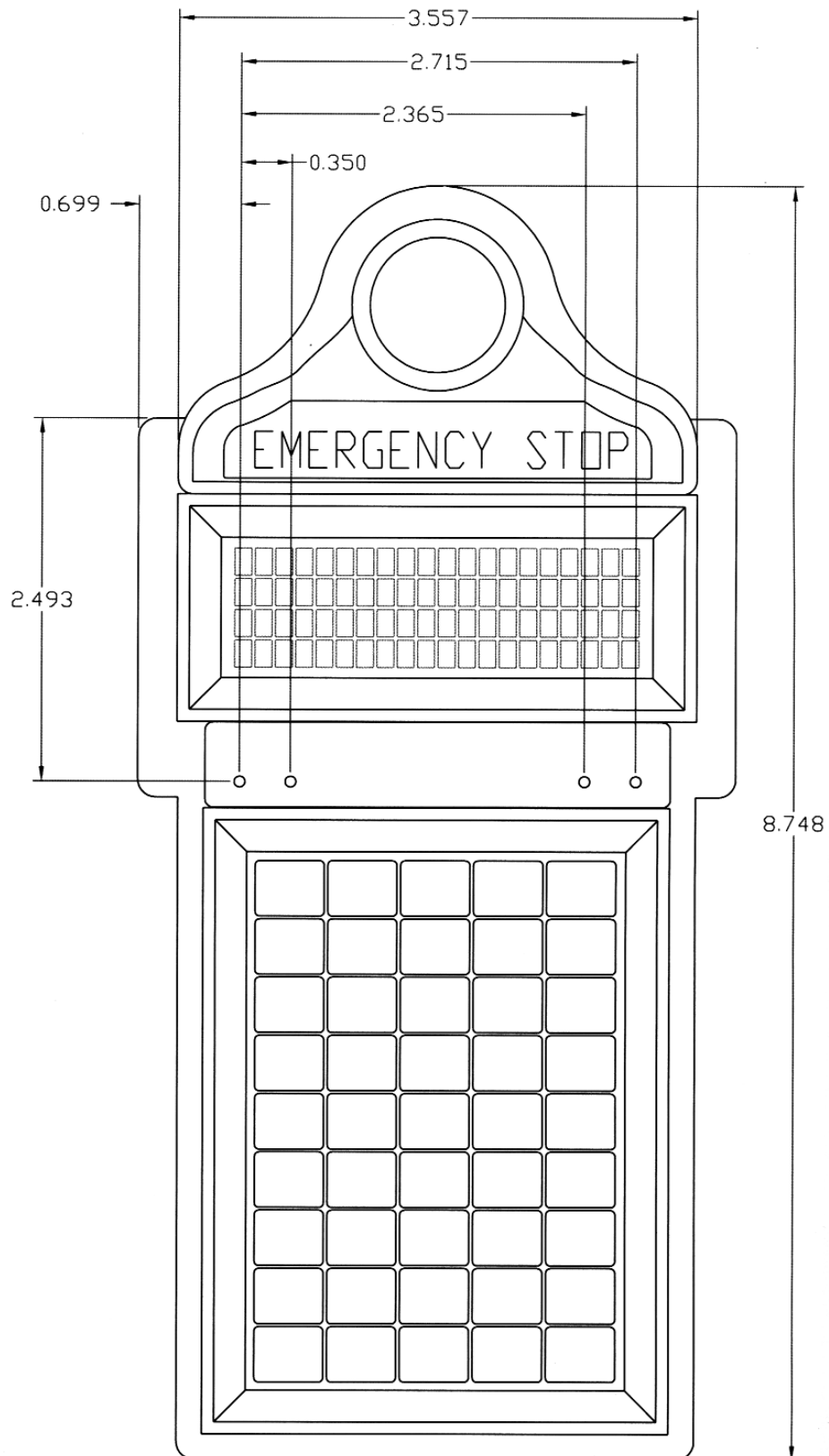
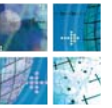

# Layout Sample

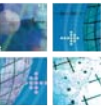

Draw in your logo and indicate the PANTONE® color(s).



Logo Tag

NOTE: Please provide us with camera-ready artwork if your corporate or product logo is required.

*NOTE: You don't need to be the next Leonardo da Vinci. Just pick-up a pen or a pencil and jot down your ideas. When you're happy with your layout, just fax it over. We have graphic designers who will turn your sketches into a masterpiece!*

## EXAMPLE:

Pantone Color(s):

1. *F1 = PMS 215*
2. *Text = Black*
3. *BKgrd = PMS Cool Gray 3*

Font & Point Size:

*Times New Roman 24 Pt.*

## EXAMPLE:

Pantone Color(s):

1. *Text = Black*
2. *BKgrd = PMS Cool Gray 3*

Font & Point Size:

*Times New Roman 24 Pt.*

Draw in your keypad and indicate the PANTONE® color(s).

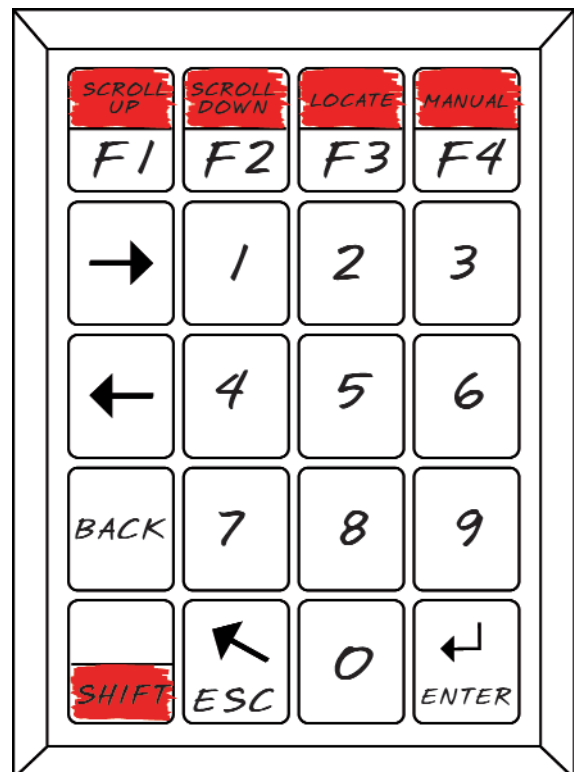

# Logo Tag Layouts

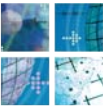

## Standard Logo Tag

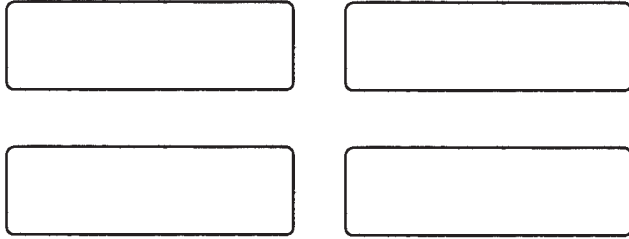

Scale 1:1

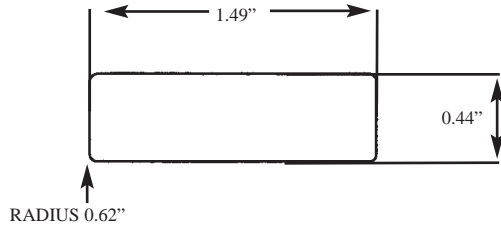

### Pantone Color(s):

1. \_\_\_\_\_
2. \_\_\_\_\_
3. \_\_\_\_\_
4. \_\_\_\_\_
5. \_\_\_\_\_
6. \_\_\_\_\_

### Font & Point Size:

\_\_\_\_\_

## Battery Logo Tag

### Pantone Color(s):

1. \_\_\_\_\_
2. \_\_\_\_\_
3. \_\_\_\_\_
4. \_\_\_\_\_
5. \_\_\_\_\_
6. \_\_\_\_\_

### Font & Point Size:

\_\_\_\_\_



## Emergency Stop Logo Tag

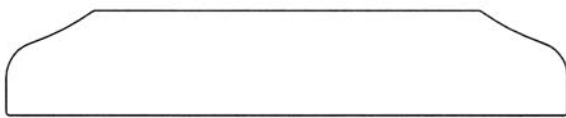

Scale 1:1

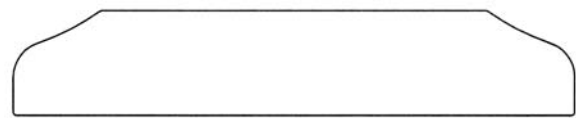

### Pantone Color(s):

1. \_\_\_\_\_
2. \_\_\_\_\_
3. \_\_\_\_\_
4. \_\_\_\_\_
5. \_\_\_\_\_
6. \_\_\_\_\_

### Font & Point Size:

\_\_\_\_\_

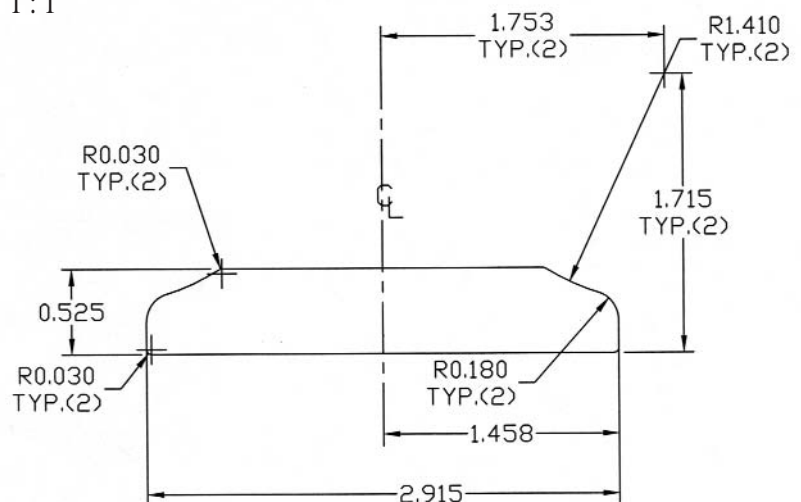

# LED Logo Tag Layout (1 of 3)

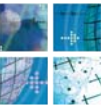

Please select a styles for your logo tag.



LED Labels Without Highlights

Yes  No



LED Labels Highlighted with Two Colors

Yes  No



LED Labels with Outlined Ovals

Yes  No

## LED Label without Highlight

example:



Background- Blue, Pantone 544

LED color- Red

LED Label- 10 pt. Impact,

Red- Pantone 186



NOTE: LEDs are in a fixed position

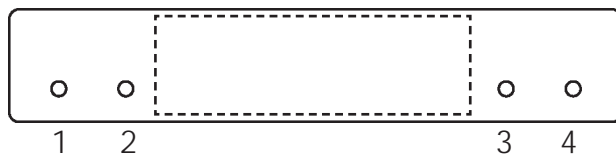

Background

Pantone Color: \_\_\_\_\_

NOTE: Please provide us with camera-ready artwork if your corporate or product logo is required.

LED COLOR 1A: \_\_\_\_\_ Line Powered Only

LED COLOR 1B: RED Low Battery-Battery Powered Only

LED COLOR 2: \_\_\_\_\_

LED COLOR 3: \_\_\_\_\_

LED COLOR 4: \_\_\_\_\_

LED LABEL 1: \_\_\_\_\_

LED LABEL 2: \_\_\_\_\_

LED LABEL 3: \_\_\_\_\_

LED LABEL 4: \_\_\_\_\_

LED LABEL PANTONE COLOR 1: \_\_\_\_\_

LED LABEL PANTONE COLOR 2: \_\_\_\_\_

LED LABEL PANTONE COLOR 3: \_\_\_\_\_

LED LABEL PANTONE COLOR 4: \_\_\_\_\_

Font & Point Size:

\_\_\_\_\_

# LED Logo Tag Layout (2 of 3)

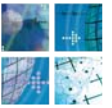

## LED Label Highlighted with Two Colors



NOTE: LEDs are in a fixed position



Background- Blue, Pantone 298

Oval- Pantone 290

LED color- Red

LED Label- 10 pt. Impact,

Red- Pantone 186

Background Pantone Color: \_\_\_\_\_

Oval Pantone Color(s):

1. \_\_\_\_\_
2. \_\_\_\_\_
3. \_\_\_\_\_
4. \_\_\_\_\_

NOTE: Please provide us with camera-ready artwork if your corporate or product logo is required.



LED COLOR 1A: \_\_\_\_\_ Line Powered Only

LED COLOR 1B: RED Low Battery-Battery Powered Only

LED COLOR 2: \_\_\_\_\_

LED COLOR 3: \_\_\_\_\_

LED COLOR 4: \_\_\_\_\_

LED LABEL 1: \_\_\_\_\_

LED LABEL 2: \_\_\_\_\_

LED LABEL 3: \_\_\_\_\_

LED LABEL 4: \_\_\_\_\_

LED LABEL PANTONE COLOR 1: \_\_\_\_\_

LED LABEL PANTONE COLOR 2: \_\_\_\_\_

LED LABEL PANTONE COLOR 3: \_\_\_\_\_

LED LABEL PANTONE COLOR 4: \_\_\_\_\_

Font & Point Size:

\_\_\_\_\_



# LED Logo Tag Layout (3 of 3)

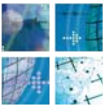

## LED Label with Outlined Ovals



NOTE: LEDs are in a fixed position

example: *Background- Blue, Pantone 2905*



*Outline- Pantone 2925*

*LED color- Red*

*LED Label- 10 pt. Impact,*

*Blue- Pantone 2945*

Background Pantone Color: \_\_\_\_\_

NOTE: Please provide us with camera-ready artwork if your corporate or product logo is required.

Outline Pantone Color(s):

1. \_\_\_\_\_
2. \_\_\_\_\_
3. \_\_\_\_\_
4. \_\_\_\_\_



LED COLOR 1A: \_\_\_\_\_ Line Powered Only

LED COLOR 1B: RED Low Battery-Battery Powered Only

LED COLOR 2: \_\_\_\_\_

LED COLOR 3: \_\_\_\_\_

LED COLOR 4: \_\_\_\_\_



LED LABEL 1: \_\_\_\_\_

LED LABEL 2: \_\_\_\_\_

LED LABEL 3: \_\_\_\_\_

LED LABEL 4: \_\_\_\_\_



LED LABEL PANTONE COLOR 1: \_\_\_\_\_

LED LABEL PANTONE COLOR 2: \_\_\_\_\_

LED LABEL PANTONE COLOR 3: \_\_\_\_\_

LED LABEL PANTONE COLOR 4: \_\_\_\_\_

Font & Point Size:

\_\_\_\_\_

# Serial Tag Layout

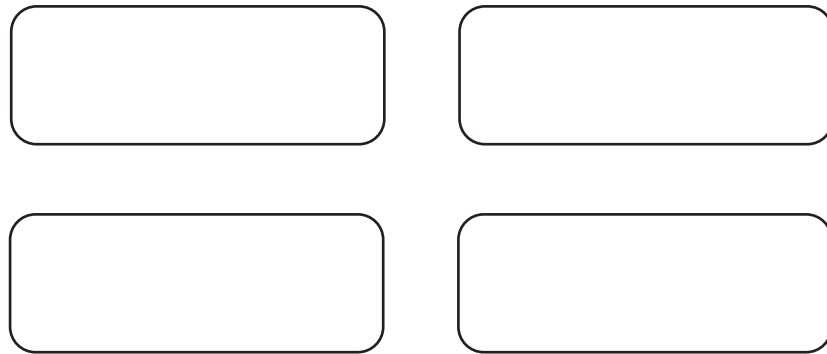
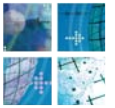

Pantone Color(s):

1. \_\_\_\_\_
2. \_\_\_\_\_
3. \_\_\_\_\_
4. \_\_\_\_\_
5. \_\_\_\_\_
6. \_\_\_\_\_

Font & Point Size:

\_\_\_\_\_

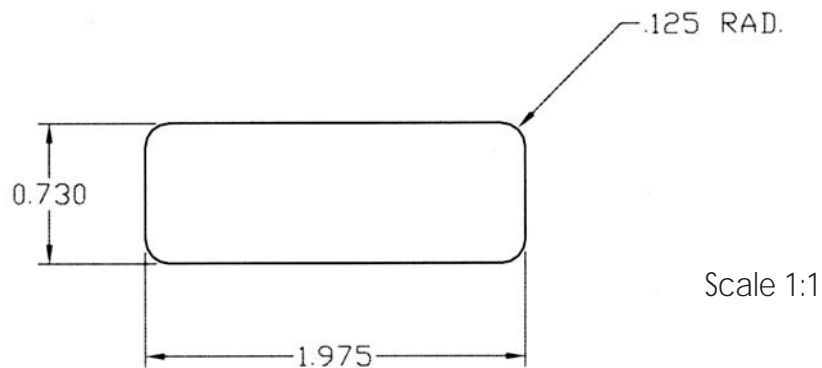

# 15-Key Membrane

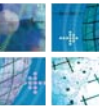

Scale 1:1

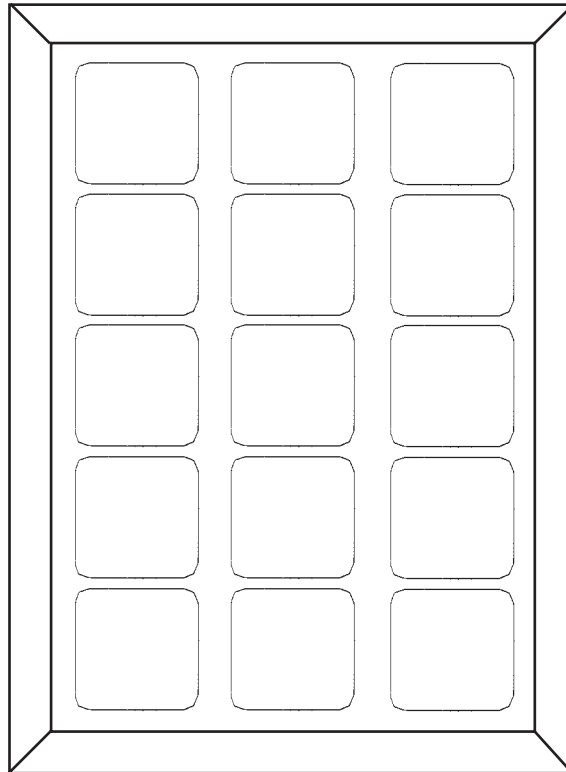

**Pantone Color(s):**

1. \_\_\_\_\_
2. \_\_\_\_\_
3. \_\_\_\_\_
4. \_\_\_\_\_
5. \_\_\_\_\_
6. \_\_\_\_\_

**Font & Point Size:**

\_\_\_\_\_

# 20-Key Membrane

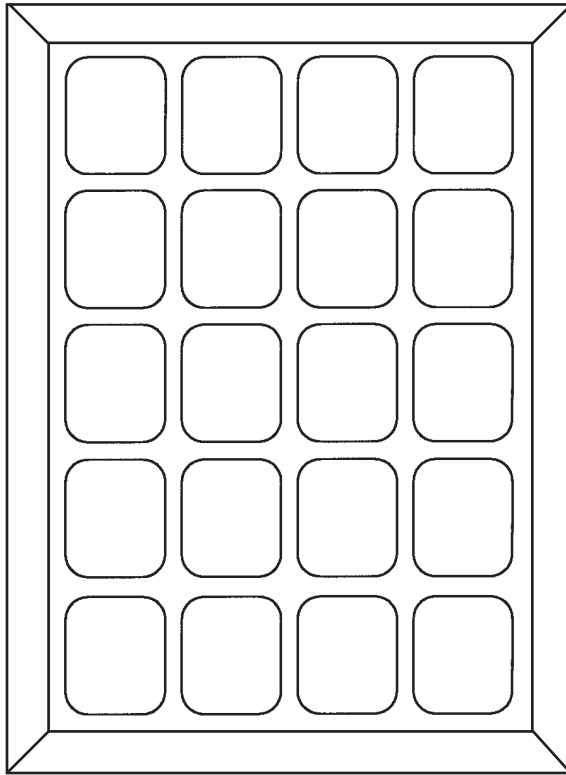
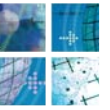

**Pantone Color(s):**

- 1. \_\_\_\_\_
- 2. \_\_\_\_\_
- 3. \_\_\_\_\_
- 4. \_\_\_\_\_
- 5. \_\_\_\_\_
- 6. \_\_\_\_\_

**Font & Point Size:**

\_\_\_\_\_

## 20-Key Elastomeric

**Pantone Color(s):**

- 1. \_\_\_\_\_
- 2. \_\_\_\_\_
- 3. \_\_\_\_\_
- 4. \_\_\_\_\_
- 5. \_\_\_\_\_
- 6. \_\_\_\_\_

**Font & Point Size:**

\_\_\_\_\_

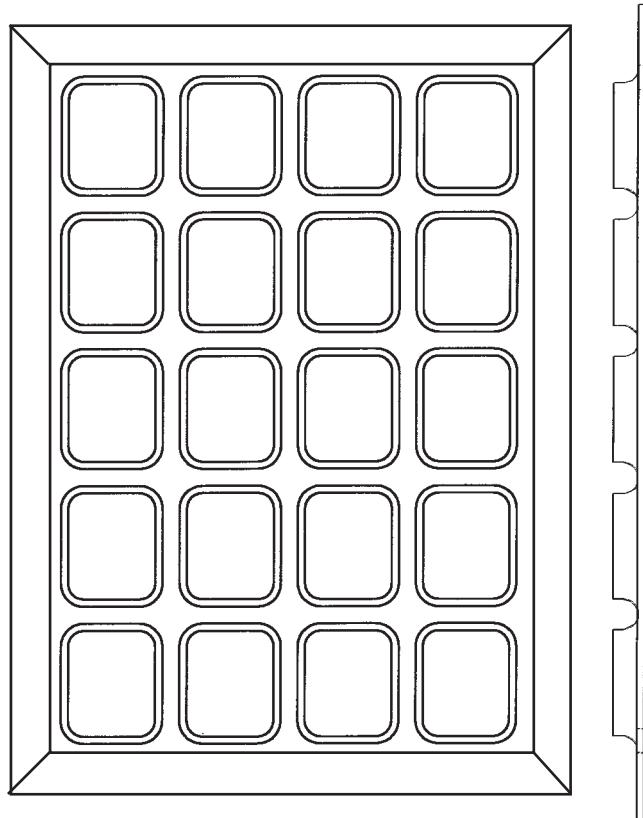

Scale 1:1

# 30-Key Membrane

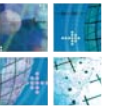

Scale 1:1

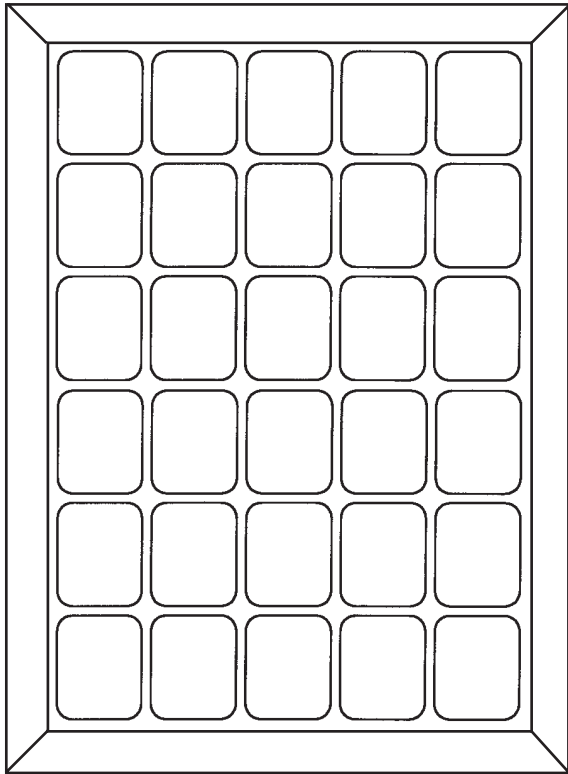

**Pantone Color(s):**

1. \_\_\_\_\_
2. \_\_\_\_\_
3. \_\_\_\_\_
4. \_\_\_\_\_
5. \_\_\_\_\_
6. \_\_\_\_\_

**Font & Point Size:**

\_\_\_\_\_

## 30-Key Elastomeric

Scale 1:1

**Pantone Color(s):**

1. \_\_\_\_\_
2. \_\_\_\_\_
3. \_\_\_\_\_
4. \_\_\_\_\_
5. \_\_\_\_\_
6. \_\_\_\_\_

**Font & Point Size:**

\_\_\_\_\_

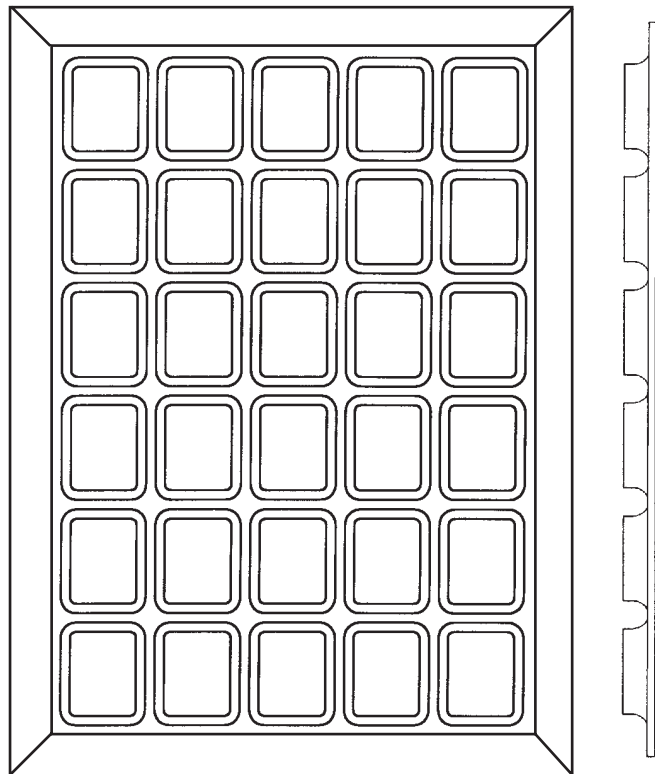

# 45-Key Membrane

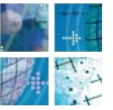

Scale 1:1

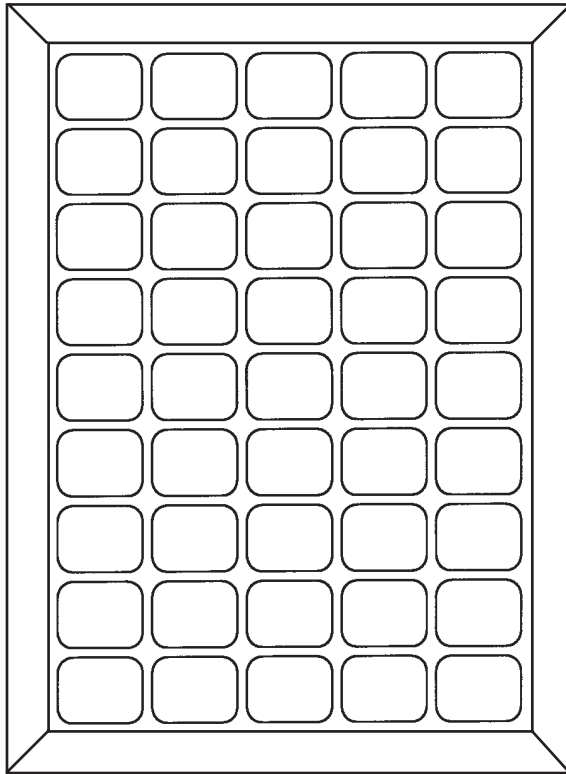

**Pantone Color(s):**

1. \_\_\_\_\_
2. \_\_\_\_\_
3. \_\_\_\_\_
4. \_\_\_\_\_
5. \_\_\_\_\_
6. \_\_\_\_\_

**Font & Point Size:**

\_\_\_\_\_

## 45-Key Elastomeric

**Pantone Color(s):**

1. \_\_\_\_\_
2. \_\_\_\_\_
3. \_\_\_\_\_
4. \_\_\_\_\_
5. \_\_\_\_\_
6. \_\_\_\_\_

**Font & Point Size:**

\_\_\_\_\_

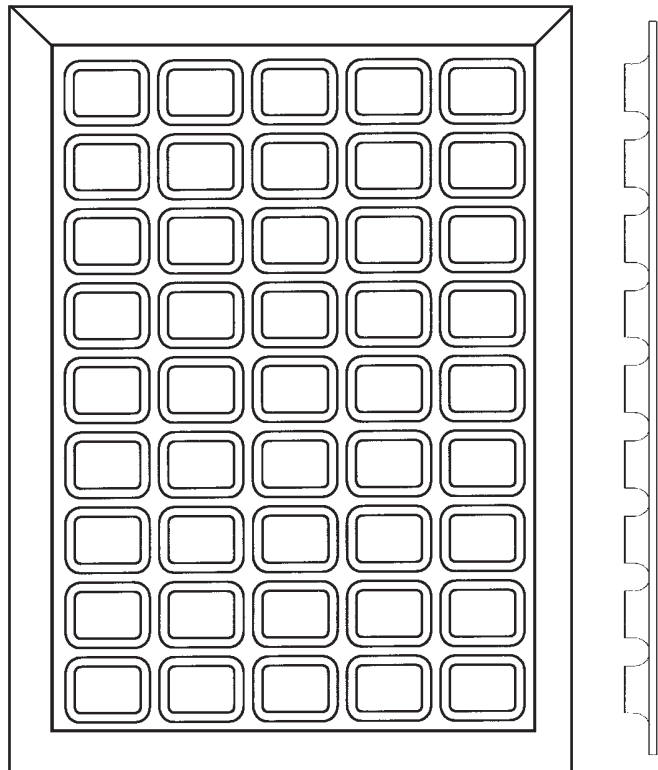

# 15-Key Custom Keycode Layout

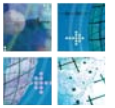

KEY	OUTPUT (HEX)	KEY	OUTPUT (HEX)	KEY	OUTPUT (HEX)	
<div style="border: 1px solid black; border-radius: 10px; padding: 5px; margin-bottom: 10px;"> <b>CS1</b> _____  <b>C1</b> _____  <b>S1</b> _____  <b>U1</b> _____                 </div> <div style="border: 1px solid black; border-radius: 10px; padding: 5px; margin-bottom: 10px;"> <b>CS6</b> _____  <b>C6</b> _____  <b>S6</b> _____  <b>U6</b> _____                 </div> <div style="border: 1px solid black; border-radius: 10px; padding: 5px; margin-bottom: 10px;"> <b>CS11</b> _____  <b>C11</b> _____  <b>S11</b> _____  <b>U11</b> _____                 </div> <div style="border: 1px solid black; border-radius: 10px; padding: 5px; margin-bottom: 10px;"> <b>CS16</b> _____  <b>C16</b> _____  <b>S16</b> _____  <b>U16</b> _____                 </div> <div style="border: 1px solid black; border-radius: 10px; padding: 5px;"> <b>CS21</b> _____  <b>C21</b> _____  <b>S21</b> _____  <b>U21</b> _____                 </div>		<div style="border: 1px solid black; border-radius: 10px; padding: 5px; margin-bottom: 10px;"> <b>CS2</b> _____  <b>C2</b> _____  <b>S2</b> _____  <b>U2</b> _____                 </div> <div style="border: 1px solid black; border-radius: 10px; padding: 5px; margin-bottom: 10px;"> <b>CS7</b> _____  <b>C7</b> _____  <b>S7</b> _____  <b>U7</b> _____                 </div> <div style="border: 1px solid black; border-radius: 10px; padding: 5px; margin-bottom: 10px;"> <b>CS12</b> _____  <b>C12</b> _____  <b>S12</b> _____  <b>U12</b> _____                 </div> <div style="border: 1px solid black; border-radius: 10px; padding: 5px; margin-bottom: 10px;"> <b>CS17</b> _____  <b>C17</b> _____  <b>S17</b> _____  <b>U17</b> _____                 </div> <div style="border: 1px solid black; border-radius: 10px; padding: 5px;"> <b>CS22</b> _____  <b>C22</b> _____  <b>S22</b> _____  <b>U22</b> _____                 </div>		<div style="border: 1px solid black; border-radius: 10px; padding: 5px; margin-bottom: 10px;"> <b>CS3</b> _____  <b>C3</b> _____  <b>S3</b> _____  <b>U3</b> _____                 </div> <div style="border: 1px solid black; border-radius: 10px; padding: 5px; margin-bottom: 10px;"> <b>CS8</b> _____  <b>C8</b> _____  <b>S8</b> _____  <b>U8</b> _____                 </div> <div style="border: 1px solid black; border-radius: 10px; padding: 5px; margin-bottom: 10px;"> <b>CS13</b> _____  <b>C13</b> _____  <b>S13</b> _____  <b>U13</b> _____                 </div> <div style="border: 1px solid black; border-radius: 10px; padding: 5px; margin-bottom: 10px;"> <b>CS18</b> _____  <b>C18</b> _____  <b>S18</b> _____  <b>U18</b> _____                 </div> <div style="border: 1px solid black; border-radius: 10px; padding: 5px;"> <b>CS23</b> _____  <b>C23</b> _____  <b>S23</b> _____  <b>U23</b> _____                 </div>		

**PREFIX**

"CS" = CTRL/SHIFT Key output\*  
 "C" = CTRL Key output  
 "S" = SHIFT Key output  
 "U" = Single Key output

\*Must have 'Shift Lock' set to enable or cancel

- Check if CTRL function is disabled
- Check if SHIFT function is disabled

**NOTES:**

# 20-Key Custom Keycode Layout

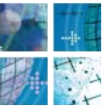

KEY	OUTPUT (HEX)	KEY	OUTPUT (HEX)	KEY	OUTPUT (HEX)	KEY	OUTPUT (HEX)
CS1	_____	CS2	_____	CS3	_____	CS4	_____
C1	_____	C2	_____	C3	_____	C4	_____
S1	_____	S2	_____	S3	_____	S4	_____
U1	_____	U2	_____	U3	_____	U4	_____
CS6	_____	CS7	_____	CS8	_____	CS9	_____
C6	_____	C7	_____	C8	_____	C9	_____
S6	_____	S7	_____	S8	_____	S9	_____
U6	_____	U7	_____	U8	_____	U9	_____
CS11	_____	CS12	_____	CS13	_____	CS14	_____
C11	_____	C12	_____	C13	_____	C14	_____
S11	_____	S12	_____	S13	_____	S14	_____
U11	_____	U12	_____	U13	_____	U14	_____
CS16	_____	CS17	_____	CS18	_____	CS19	_____
C16	_____	C17	_____	C18	_____	C19	_____
S16	_____	S17	_____	S18	_____	S19	_____
U16	_____	U17	_____	U18	_____	U19	_____
CS21	_____	CS22	_____	CS23	_____	CS24	_____
C21	_____	C22	_____	C23	_____	C24	_____
S21	_____	S22	_____	S23	_____	S24	_____
U21	_____	U22	_____	U23	_____	U24	_____

**PREFIX**  
 "CS" = CTRL/SHIFT Key output\*  
 "C" = CTRL Key output  
 "S" = SHIFT Key output  
 "U" = Single Key output

\*Must have 'Shift Lock' set to enable or cancel

- Check if CTRL function is disabled
- Check if SHIFT function is disabled

**NOTES:**



# 20-Key Standard Hex Output Table

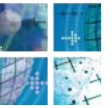

KEY	OUTPUT (HEX)	KEY	OUTPUT (HEX)	KEY	OUTPUT (HEX)	KEY	OUTPUT (HEX)
CS1 C1 S1 U1	41	CS2 C2 S2 U2	42	CS3 C3 S3 U3	43	CS4 C4 S4 U4	44
CS6 C6 S6 U6	31	CS7 C7 S7 U7	32	CS8 C8 S8 U8	33	CS9 C9 S9 U9	2B
CS11 C11 S11 U11	34	CS12 C12 S12 U12	35	CS13 C13 S13 U13	36	CS14 C14 S14 U14	2D
CS16 C16 S16 U16	37	CS17 C17 S17 U17	38	CS18 C18 S18 U18	39	CS19 C19 S19 U19	08
CS21 C21 S21 U21	2E	CS22 C22 S22 U22	30	CS23 C23 S23 U23	20	CS24 C24 S24 U24	0D

## PREFIX

"CS" = CTRL/SHIFT Key output\*

"C" = CTRL Key output

"S" = SHIFT Key output

"U" = Single Key output

\*Must have 'Shift Lock' set to enable or cancel

# 30-Key Custom Keycode Layout

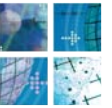

KEY	OUTPUT (HEX)	KEY	OUTPUT (HEX)	KEY	OUTPUT (HEX)	KEY	OUTPUT (HEX)	KEY	OUTPUT (HEX)
CS1	_____	CS2	_____	CS3	_____	CS4	_____	CS5	_____
C1	_____	C2	_____	C3	_____	C4	_____	C5	_____
S1	_____	S2	_____	S3	_____	S4	_____	S5	_____
U1	_____	U2	_____	U3	_____	U4	_____	U5	_____
CS6	_____	CS7	_____	CS8	_____	CS9	_____	CS10	_____
C6	_____	C7	_____	C8	_____	C9	_____	C10	_____
S6	_____	S7	_____	S8	_____	S9	_____	S10	_____
U6	_____	U7	_____	U8	_____	U9	_____	U10	_____
CS11	_____	CS12	_____	CS13	_____	CS14	_____	CS15	_____
C11	_____	C12	_____	C13	_____	C14	_____	C15	_____
S11	_____	S12	_____	S13	_____	S14	_____	S15	_____
U11	_____	U12	_____	U13	_____	U14	_____	U15	_____
CS16	_____	CS17	_____	CS18	_____	CS19	_____	CS20	_____
C16	_____	C17	_____	C18	_____	C19	_____	C20	_____
S16	_____	S17	_____	S18	_____	S19	_____	S20	_____
U16	_____	U17	_____	U18	_____	U19	_____	U20	_____
CS21	_____	CS22	_____	CS23	_____	CS24	_____	CS25	_____
C21	_____	C22	_____	C23	_____	C24	_____	C25	_____
S21	_____	S22	_____	S23	_____	S24	_____	S25	_____
U21	_____	U22	_____	U23	_____	U24	_____	U25	_____
CS26	_____	CS27	_____	CS28	_____	CS29	_____	CS30	_____
C26	_____	C27	_____	C28	_____	C29	_____	C30	_____
S26	_____	S27	_____	S28	_____	S29	_____	S30	_____
U26	_____	U27	_____	U28	_____	U29	_____	U30	_____

## PREFIX

"CS" = CTRL/SHIFT Key output\*  
 "C" = CTRL Key output  
 "S" = SHIFT Key output  
 "U" = Single Key output

\*Must have 'Shift Lock' set to enable or cancel

## NOTES :

- Check if CTRL function is disabled
- Check if SHIFT function is disabled

# 30-Key Standard Hex Output Table

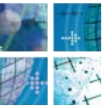

KEY	OUTPUT (HEX)	KEY	OUTPUT (HEX)	KEY	OUTPUT (HEX)	KEY	OUTPUT (HEX)	KEY	OUTPUT (HEX)
<b>CS1</b>	61	<b>CS2</b>	62	<b>CS3</b>	63	<b>CS4</b>	64	<b>CS5</b>	65
<b>C1</b>	01	<b>C2</b>	02	<b>C3</b>	03	<b>C4</b>	04	<b>C5</b>	--
<b>S1</b>	11	<b>S2</b>	12	<b>S3</b>	13	<b>S4</b>	14	<b>S5</b>	15
<b>U1</b>	41	<b>U2</b>	42	<b>U3</b>	43	<b>U4</b>	44	<b>U5</b>	45
<b>CS6</b>	66	<b>CS7</b>	67	<b>CS8</b>	68	<b>CS9</b>	69	<b>CS10</b>	6A
<b>C6</b>	06	<b>C7</b>	07	<b>C8</b>	08	<b>C9</b>	09	<b>C10</b>	0A
<b>S6</b>	2F	<b>S7</b>	28	<b>S8</b>	31	<b>S9</b>	32	<b>S10</b>	33
<b>U6</b>	46	<b>U7</b>	47	<b>U8</b>	48	<b>U9</b>	49	<b>U10</b>	4A
<b>CS11</b>	6B	<b>CS12</b>	6C	<b>CS13</b>	6D	<b>CS14</b>	6E	<b>CS15</b>	6F
<b>C11</b>	0B	<b>C12</b>	0C	<b>C13</b>	0D	<b>C14</b>	0E	<b>C15</b>	0F
<b>S11</b>	2A	<b>S12</b>	29	<b>S13</b>	34	<b>S14</b>	35	<b>S15</b>	36
<b>U11</b>	4B	<b>U12</b>	4C	<b>U13</b>	4D	<b>U14</b>	4E	<b>U15</b>	4F
<b>CS16</b>	70	<b>CS17</b>	71	<b>CS18</b>	72	<b>CS19</b>	73	<b>CS20</b>	74
<b>C16</b>	10	<b>C17</b>	11	<b>C18</b>	12	<b>C19</b>	13	<b>C20</b>	14
<b>S16</b>	2D	<b>S17</b>	23	<b>S18</b>	37	<b>S19</b>	38	<b>S20</b>	39
<b>U16</b>	50	<b>U17</b>	51	<b>U18</b>	52	<b>U19</b>	53	<b>U20</b>	54
<b>CS21</b>	75	<b>CS22</b>	76	<b>CS23</b>	77	<b>CS24</b>	78	<b>CS25</b>	79
<b>C21</b>	15	<b>C22</b>	16	<b>C23</b>	17	<b>C24</b>	18	<b>C25</b>	19
<b>S21</b>	2B	<b>S22</b>	2C	<b>S23</b>	3D	<b>S24</b>	30	<b>S25</b>	2E
<b>U21</b>	55	<b>U22</b>	56	<b>U23</b>	57	<b>U24</b>	58	<b>U25</b>	59
<b>CS26</b>	7A	<b>CS27</b>	20	<b>CS28</b>	0D	<b>CTRL</b>		<b>SHIFT</b>	
<b>C26</b>	1A	<b>C27</b>	--						
<b>S26</b>	1B	<b>S27</b>	08						
<b>U26</b>	5A	<b>U27</b>	20						
				<b>C28</b>	--				
				<b>S28</b>	0D				
				<b>U28</b>	0D				

## PREFIX

"CS" = CTRL/SHIFT Key output\*

"C" = CTRL Key output

"S" = SHIFT Key output

"U" = Single Key output

\*Must have 'Shift Lock' set to enable or cancel

# 45-Key Custom Keycode Layout

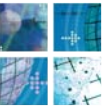

KEY	OUTPUT (HEX)	KEY	OUTPUT (HEX)	KEY	OUTPUT (HEX)	KEY	OUTPUT (HEX)	KEY	OUTPUT (HEX)
CS1	_____	CS2	_____	CS3	_____	CS4	_____	CS5	_____
C1	_____	C2	_____	C3	_____	C4	_____	C5	_____
S1	_____	S2	_____	S3	_____	S4	_____	S5	_____
U1	_____	U2	_____	U3	_____	U4	_____	U5	_____
CS6	_____	CS7	_____	CS8	_____	CS9	_____	CS10	_____
C6	_____	C7	_____	C8	_____	C9	_____	C10	_____
S6	_____	S7	_____	S8	_____	S9	_____	S10	_____
U6	_____	U7	_____	U8	_____	U9	_____	U10	_____
CS11	_____	CS12	_____	CS13	_____	CS14	_____	CS15	_____
C11	_____	C12	_____	C13	_____	C14	_____	C15	_____
S11	_____	S12	_____	S13	_____	S14	_____	S15	_____
U11	_____	U12	_____	U13	_____	U14	_____	U15	_____
CS16	_____	CS17	_____	CS18	_____	CS19	_____	CS20	_____
C16	_____	C17	_____	C18	_____	C19	_____	C20	_____
S16	_____	S17	_____	S18	_____	S19	_____	S20	_____
U16	_____	U17	_____	U18	_____	U19	_____	U20	_____
CS21	_____	CS22	_____	CS23	_____	CS24	_____	CS25	_____
C21	_____	C22	_____	C23	_____	C24	_____	C25	_____
S21	_____	S22	_____	S23	_____	S24	_____	S25	_____
U21	_____	U22	_____	U23	_____	U24	_____	U25	_____
CS26	_____	CS27	_____	CS28	_____	CS29	_____	CS30	_____
C26	_____	C27	_____	C28	_____	C29	_____	C30	_____
S26	_____	S27	_____	S28	_____	S29	_____	S30	_____
U26	_____	U27	_____	U28	_____	U29	_____	U30	_____
CS31	_____	CS32	_____	CS33	_____	CS34	_____	CS35	_____
C31	_____	C32	_____	C33	_____	C34	_____	C35	_____
S31	_____	S32	_____	S33	_____	S34	_____	S35	_____
U31	_____	U32	_____	U33	_____	U34	_____	U35	_____
CS36	_____	CS37	_____	CS38	_____	CS39	_____	CS40	_____
C36	_____	C37	_____	C38	_____	C39	_____	C40	_____
S36	_____	S37	_____	S38	_____	S39	_____	S40	_____
U36	_____	U37	_____	U38	_____	U39	_____	U40	_____
CS41	_____	CS42	_____	CS43	_____	CS44	_____	CS45	_____
C41	_____	C42	_____	C43	_____	C44	_____	C45	_____
S41	_____	S42	_____	S43	_____	S44	_____	S45	_____
U41	_____	U42	_____	U43	_____	U44	_____	U45	_____

## PREFIX

"CS" = CTRL/SHIFT Key output\*  
 "C" = CTRL Key output  
 "S" = SHIFT Key output  
 "U" = Single Key output

\*Must have 'Shift Lock' set to enable or cancel

## NOTES:

- Check if CTRL function is disabled
- Check if SHIFT function is disabled

# 45-Key Standard Hex Output Table

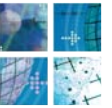

KEY	OUTPUT (HEX)	KEY	OUTPUT (HEX)	KEY	OUTPUT (HEX)	KEY	OUTPUT (HEX)	KEY	OUTPUT (HEX)
CS1	11	CS2	12	CS3	13	CS4	14	CS5	15
C1	1B 5B 41	C2	1B 5B 42	C3	1B 5B 43	C4	1B 5B 44	C5	--
S1	06	S2	07	S3	08	S4	09	S5	0A
U1	11	U2	12	U3	13	U4	14	U5	15
CS6	61	CS7	62	CS8	63	CS9	64	CS10	65
C6	01	C7	02	C8	03	C9	04	C10	05
S6	2B	S7	28	S8	29	S9	3C	S10	3E
U6	41	U7	42	U8	43	U9	44	U10	45
CS11	66	CS12	67	CS13	68	CS14	69	CS15	6A
C11	06	C12	07	C13	08	C14	09	C15	0A
S11	2D	S12	21	S13	5F	S14	5B	S15	5D
U11	46	U12	47	U13	48	U14	49	U15	4A
CS16	6B	CS17	6C	CS18	6D	CS19	6E	CS20	6F
C16	0B	C17	0C	C18	0D	C19	0E	C20	0F
S16	2F	S17	26	S18	3A	S19	3B	S20	3F
U16	4B	U17	4C	U18	4D	U19	4E	U20	4F
CS21	70	CS22	71	CS23	37	CS24	38	CS25	39
C21	10	C22	11	C23	--	C24	--	C25	--
S21	2A	S22	40	S23	37	S24	38	S25	39
U21	50	U22	51	U23	37	U24	38	U25	39
CS26	72	CS27	73	CS28	34	CS29	35	CS30	36
C26	12	C27	13	C28	--	C29	--	C30	--
S26	3D	S27	23	S28	34	S29	35	S30	36
U26	52	U27	53	U28	34	U29	35	U30	36
CS31	74	CS32	75	CS33	31	CS34	32	CS35	33
C31	14	C32	15	C33	--	C34	--	C35	--
S31	5E	S32	24	S33	31	S34	32	S35	33
U31	54	U32	55	U33	31	U34	32	U35	33
CS36	76	CS37	77	CS38	78	CS39	30	<b>CTRL</b>	
C36	16	C37	17	C38	18	C39	--		
S36	2C	S37	25	S38	2E	S39	30	<b>SHIFT</b>	
U36	56	U37	57	U38	58	U39	30		
CS41	79	CS42	7A	CS43	20	CS44	0D		
C41	19	C42	1A	C43	--	C44	--		
S41	22	S42	1B	S43	08	S44	0D		
U41	59	U42	5A	U43	20	U44	0D		

## PREFIX

"CS" = CTRL/SHIFT Key output\*

"C" = CTRL Key output

"S" = SHIFT Key output

"U" = Single Key output

\*Must have 'Shift Lock' set to enable or cancel

# 80 Series Custom Default Worksheet



Please check off only **ONE** box for each default parameter selection!

Note: Underlined Boxes  indicate standard factory default settings.

## Default Parameter Settings

1. Baud Rate (bits/second):  300  600  1200  2400  4800  9600  19200
2. Data Bits:  7  8
3. Parity:  Even  Odd  Mark  Space  None  Ignore
5. Stop Bits:  1  2
4. Display PE:  Enable  Disable
6. Repeat:  Slow  Medium  Fast  Disabled
7. Key Click:  Enable  Disable
8. KNP Function:  Enable  Disable
9. Cursor:  Enable  Disable
10. Cursor Blink:  Enable  Disable
11. XON/XOFF (software handshake):  Enable  Disable
12. Handshake (hardware):  Enable  Disable
13. Echo:  Enable  Disable
14. Escape Mode:  Ansi  Private
15. CR/LF Mode:  Normal  Newline
16. Test (power-on self test):  Enable  Disable
17. Shift Lock (shift & CTRL latching):  Enable  Disable  Cancel
18. Scroll (autoscroll point):  80  81
19. Viewing Angle (display contrast):  MIN  2  3  4  5  6  7  MAX
20. Break Cmnd:  Enable  Disable
21. Backlight:  On  Timed  Off

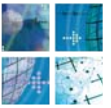

## Access Restrictions

1. Function Key Programming via Keypad:
2. Access to Parameters Menu via Keypad:
3. "Serial" Parameters Modifications:
4. Programming of Custom Characters:

## Allow Access

- Yes  No
- Yes  No
- Yes  No
- Yes  No

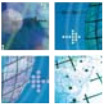

## Cable Types

- Straight Cable - Round Jacket     Straight Cable - Flat Jacket  
 Coiled Cable - Round Jacket     Coiled Cable - Flat Jacket

## Cable Length

- 7 Foot     15 Foot     Custom - Length= \_\_\_\_\_

## Cable Color

- Black     Gray  
 Other (Custom) \_\_\_\_\_

## Shielding

- Unshielded     Shielded  
Shield Termination at Host \_\_\_\_\_  
Shield Termination at Terminal \_\_\_\_\_

## Wire Size

- 26GA (Std. for all cables)  
 Other (Custom) \_\_\_\_\_

## Custom Connector Information

Connector Type: \_\_\_\_\_

Connector Manufacturer: \_\_\_\_\_

Manufacturer Part No: \_\_\_\_\_

Qty: \_\_\_\_\_

- Sketch Attached     Sample Attached



# Connector Pin Outs



(Required at time of order)

RS-232

Terminal

YOUR CORRESPONDING PINS

- |                               |       |
|-------------------------------|-------|
| 1 +Supply to Terminal         | _____ |
| 2 Handshake into Terminal     | _____ |
| 3 Handshake out from Terminal | _____ |
| 4 Data into Terminal          | _____ |
| 5 Data out from Terminal      | _____ |
| 6 Common                      | _____ |

RS-422

Terminal

YOUR CORRESPONDING PINS

- |                           |       |
|---------------------------|-------|
| 1 +Supply to Terminal     | _____ |
| 2 +Data into Terminal     | _____ |
| 3 +Data out from Terminal | _____ |
| 4 -Data into Terminal     | _____ |
| 5 -Data out from Terminal | _____ |
| 6 Common                  | _____ |

RS-485

Terminal

YOUR CORRESPONDING PINS

- |                       |       |
|-----------------------|-------|
| 1 +Supply to Terminal | _____ |
| 2 Not Used            | _____ |
| 3 +Data               | _____ |
| 4 Not Used            | _____ |
| 5 -Data               | _____ |
| 6 Common              | _____ |